

GMG



Amazing in any challenge

 **FIMAP**<sup>®</sup>

Reduce cost to clean and get the greatest return on your investment in short term



## POWER

- Increase productivity, by cleaning with greater power and 30% faster than a conventional model of the same category
- Increase productivity, by cleaning ramps with slopes up to 20% at full load
- Increase productivity, with the possibility to install batteries of different technologies, from lead acid batteries to advanced lithium-ion ones, which provide up to 10 hours of run time on a single charge
- Reduce the time required for U-turns within logistics centres aisles, by changing direction in one smooth manoeuvre
- Increase operator productivity, with enhanced control over tasks provided by the touchscreen display and the rear view camera
- Increase operator productivity, providing up to 9 pre-set cleaning programs according to different applications
- Save on operating costs, with the low maintenance required by brushless motors

## SPEED

up to **9** km/h  
at work

## PRODUCTIVITY

**+30%**

## GRADEABILITY

slopes up to **20%**  
on duty at full load

## RUN TIME

up to **10** hours







## SIMPLICITY

- Reduce operator training, with on-board video tutorials which show how to perform common operation and maintenance activities
- Increase uptime, with easy and intuitive access to key features through the iD – Intelligent Drive system
- Enhance control over cleaning results, with pre-set work programs and supervisor controls that ensure proper machine setting and use by the operator
- Reduce service time and cost, with fully accessible design that enables easy and quick servicing

## SUSTAINABILITY

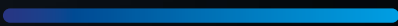
- Reduce the use of resources, saving water, chemical and energy thanks to Fimap sustainable technologies
- Reduce the environmental impact, with constant control of the CO<sub>2</sub> produced
- Reduce water use up to 66% with FLR – Fimap Long Range technology, that allows you to clean more sq.m with the same amount of resources

FSS  
 up to **50%**  
reduces water and chemical use

FLR  
 up to **66%**  
reduces water and chemical use

## DURABILITY

- Protect the machine and the facility in which it works, with steel wrap-around bumper and roller bumpers at the 4 corners

## SAFETY

- Increase operator and facility safety, thanks to the array of active and passive safety technologies provided as standard

## CONNECTIVITY

- Increase productivity by tracking performance with Fimap My.Machine app

## CUSTOMIZATION

- Increase productivity by customizing GMG to your specific needs



# GMG

A scrubbing machine designed to exceed your expectations in the most demanding industries



LOGISTICS



PARKING LOTS



TRANSPORTATION



INDUSTRY



LARGE-SCALE  
RETAIL





## Accurate details highlight the robustness of its design

It stands out for the strength of its design that enhances the sense of protection



### PROTECTION

- **FOR ENVIRONMENTS**  
It blends in perfectly, has no protruding parts
- **FOR THE USER**  
It has a comfortable and safe driving position that enhances visibility and control
- **FOR THE MACHINE ITSELF**  
Long-lasting, rotationally-moulded plastic tanks and a wrap-around steel bumper keep the mechanical components safe.



The front and rear sensors prevent collisions, by alerting the operator when approaching an obstacle





## BRUSHLESS MOTORS

Motors without brushes bring several advantages:

- **MORE POWER**, which is entirely used avoiding the dispersion that is normally caused by the friction of the brushes
- **GREATER DURABILITY OVER TIME**, as they do not generate heat, there is no need for ventilation which can cause damaging seepages
- **COMPACT DESIGN**, they leave more space to the volume of the tanks, thus increasing the working autonomy
- **GREATER CONTROL**, which being electronic, and not electromechanical, automatically adjusts to the required performance, improving efficiency
- **NO MAINTENANCE** and extremely longer life cycle

ENDURANCE OVER TIME

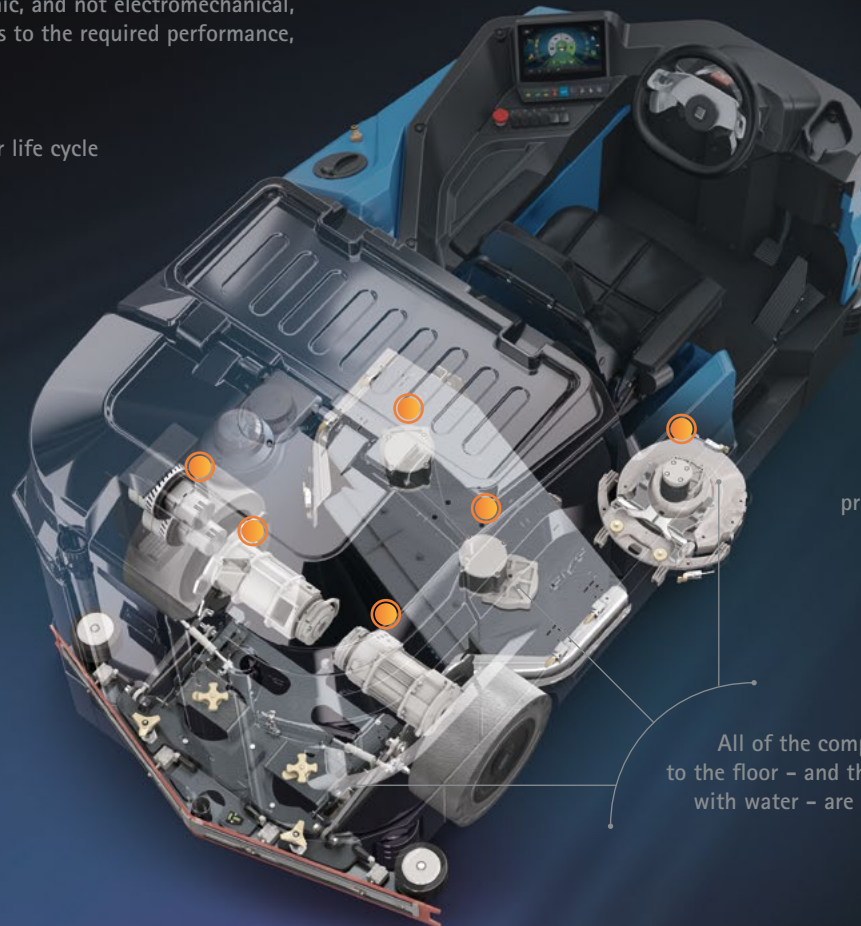
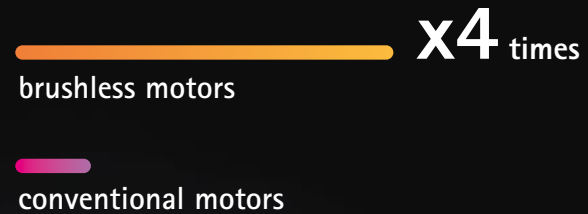

The roller bumpers at the 4 corners deflect shocks protecting the machine and extending its life

All of the components close to the floor – and therefore in contact with water – are corrosion-proof

# GMG

## A comfortable space enables the operator to better focus on the cleaning task

Every single detail of the driving position is designed to provide the perfect working conditions: a comfortable seat, easy access to controls, full control of activities, smooth manoeuvres, total visibility of the surrounding space

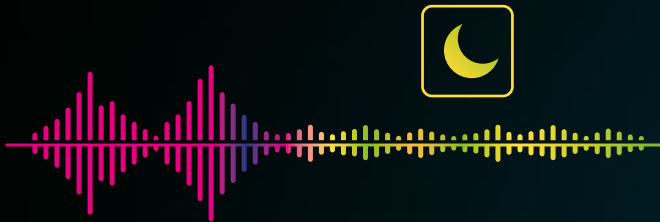

The Eco Mode device reduces the noise level to clean without disturbing the other people around





A convenient step helps to sit in the driver's seat

Side paddles integrated into the steering wheel help the operator keep his attention and eyes on the driving direction

The digital touch screen display creates a modern, high-tech environment where valuable information is shown in high resolution

The side control panel provides easy access to functions, allowing the operator to work on settings without getting distracted

Integrated USB ports for charging mobile devices



Comfort driver's seat

The seat, with armrests and headrest, is sprung and adjustable, to suit the operator's needs, thus improving driving comfort



Learning how to take care of GMG is easy,  
because it is the machine itself that guides you



OPERATOR  
TRAINING  
VIDEO  
TUTORIALS

They provide essential instructions to perform routine activities and to support the operator when a quick reminder is needed on proper operation and maintenance procedures



MAINTENANCE  
DUE WARNING

When the deadline for the periodic inspection established in the maintenance plan is approaching, a warning appears on the display, giving you plenty of time to arrange your appointment.



USE AND MAINTENANCE MANUAL  
AND SPARE PARTS CATALOGUE

It is possible to read directly from the display the Spare Parts Catalogue and the Use and Maintenance Manual, available in 24 languages. Any doubts concerning the machine can be solved immediately, thanks to the easy-to-read touchscreen display.





## SERVICE LIGHTS



The exclusive lights pack offers increased visibility of the parts which could require operator inspection, illuminating the relative zones with LED lights

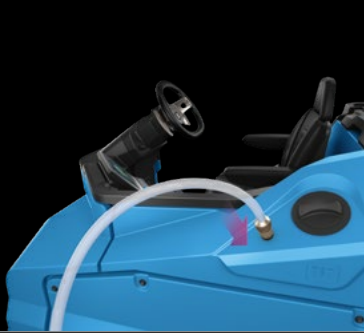

## FFF-FIMAP FAST FILL

It enables the solution tank to be filled up quickly without the presence of the operator



## SPRAY GUN

The spray gun enables the cleaning of the recovery tank anywhere, even when there is no available tap nearby, reducing maintenance downtime.

## REAR FOOTBOARD

A convenient pull-down footboard at the rear of the machine provides easy access to the tanks and a better view for maintenance activities



## MAINTENANCE TOUCH POINT

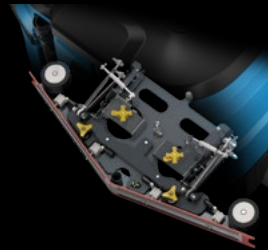

## YELLOW COLOUR-CODED PARTS

Parts which must be cleaned regularly at the end of every shift are colour coded in yellow for easy identification, saving time and making sure that your scrubbing machine is kept in perfect condition at all times

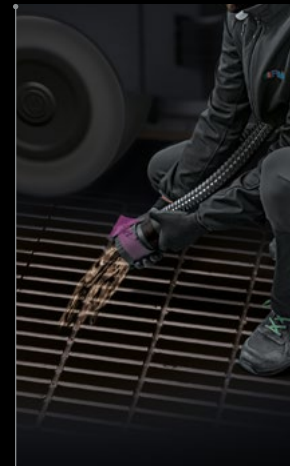

## LARGE DIAMETER HOSES

The large diameter of the drain hoses allows the tanks to be emptied quickly, reducing downtime. The hoses feature a flow adjustment system that enables to choose up to 5 opening sizes in order to adapt the diameter to the flow when emptying the tanks

## Outstanding performance in any challenge



### DUAL 3-STAGE VACUUM MOTOR

Effective vacuum system which leaves the floor dry with no risk of slipping



The layout of the squeegees helps to collect water and direct it towards the suction point, thus ensuring better drying.

The floor is perfectly dried even in bends, thanks to the lateral movement of the rear squeegee, which always follows the course of the machine.

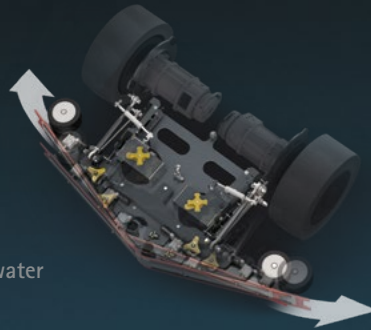

**FLR**

FLR-FIMAP LONG RANGE

PRODUCTIVITY IS INCREASED BY UP TO



### RUN TIME



with Li-ion batteries



\* In Eco Mode

### SPEED

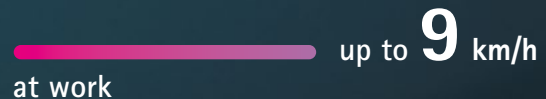
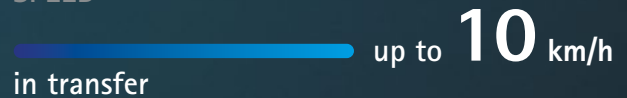

### PRODUCTIVITY

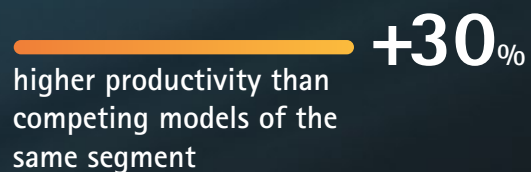





**300**  
litres

SOLUTION  
TANK

**350**  
litres

RECOVERY  
TANK



### SIDE BRUSH WITH VACUUM SYSTEM

The side brush makes it easy to clean along walls and allows to reach under shelves. It is equipped with vacuum system, a unique innovation not available in any other model in the market, which increases drying performance even on bends

IT WIDENS THE WORKING WIDTH,  
THUS INCREASING PRODUCTIVITY BY UP TO

**+20%**



GREATER CLEANING POWER TO TACKLE THE MOST STUBBORN DIRT

Adjustable brush pressure up to **250** kg

Brush rpm up to **315**



### VACUUM WAND

Enables cleaning areas that are difficult to reach with the machine and completing the operation every time



# GMG

## A power never seen before in a scrubber dryer

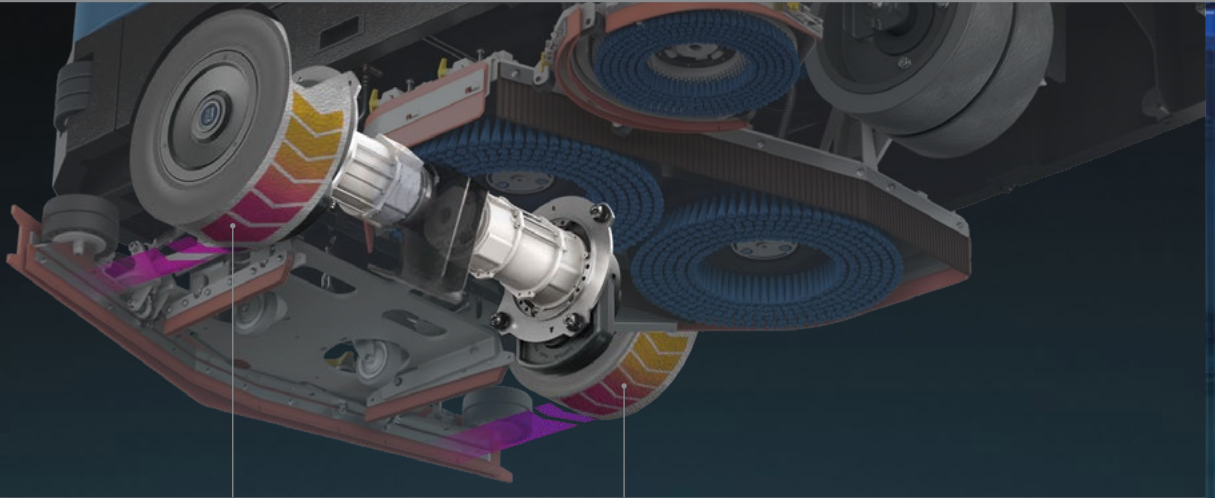

RAMP UP

### REAR-WHEEL TRACTION WITH 2 INDEPENDENT MOTOR WHEELS

The rear-wheel traction with 2 electronically controlled independent wheels provides GMG with the necessary power to easily overcome ramps of up to 20% working.

In a multistorey car park, GMG is therefore able to move easily from one level to another, guaranteeing high grip when climbing, reliability and maximum control when manoeuvring.





it can clean ramps with slopes up to **20%**

it can overcome trailer ramps with slopes up to **30%\***



\* empty in transfer using a hoist





## MINIMUM AISLE TURN

**2500** mm

The combination of rear-wheel traction and independent motor wheels allows a small turning radius, which remains within the machine diagonal of 2500 mm. As a result, the space required for manoeuvring is also minimal.

The friction that is usually generated in reversing causes a significant consumption of energy, which negatively affects the working range.

The action of the independent rear motor wheels together with the double front wheel of GMG considerably reduces the friction produced when steering. This avoids unnecessary energy dispersion, extends battery run time and increases productivity.

## Power steering improves comfort

The power steering makes the steering wheel lighter, increases manoeuvrability and reduces the operator fatigue while driving.



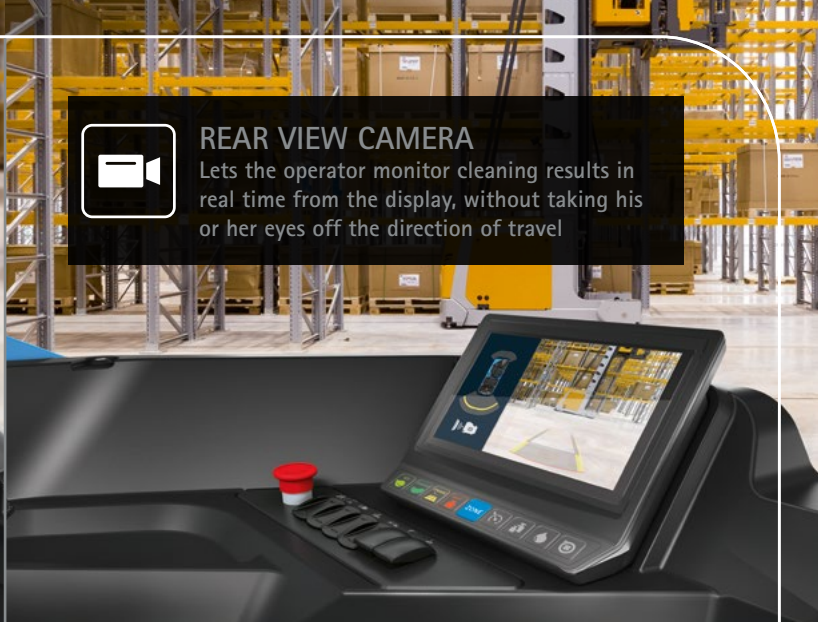

## REAR VIEW CAMERA

Lets the operator monitor cleaning results in real time from the display, without taking his or her eyes off the direction of travel

## FUNCTIONS TO INCREASE POWER

The Power Mode and Heavy Mode functions allow you to get the maximum cleaning power instantly, by activating just one control. Vacuuming power, brush pressure and detergent solution flow rate are raised to the highest level.



### POWER MODE

A simple touch of the side paddle raises the cleaning functions to the maximum for 120 seconds. This function is effective when the operator finds a small area with adherent dirt during the cleaning operation. In this case, it is useful to temporarily leave the cleaning configuration in use in order to benefit from the maximum cleaning power to remove localised dirt.

 for **120** seconds  
Maximum cleaning power



### HEAVY MODE

Maximum activation of cleaning functions has no time limits. It is a working mode, suitable for very dirty environments. The operator simply presses the Heavy Mode button to start working at maximum performance for as long as it is needed.



Maximum cleaning power with no time limits!

## Get access to more information to improve performance, enter the digital world of GMG

### ON-BOARD COMPUTER

With the touchscreen display you have access to information that is essential to make more efficient choices and enhance the professionalism of interventions, thus increasing productivity and reducing costs.

Display at any time:



- telemetry to track the energy consumption of the functions



- report of usage time, sq.m. cleaned and liters of water used



- remaining autonomy of batteries and tank, and projection of savings that can be achieved in Eco Mode



### iD-intelligent Drive



TOUCH SCREEN  
DISPLAY



LOG-IN  
WITH PASSWORD



ZONE  
PROGRAMS



CRUISE  
CONTROL



SUSTAINABLE  
CLEANING



MAINTENANCE  
CLEANING



FAST  
CLEANING



HEAVY-DUTY  
CLEANING



TIMED CLEANING  
POWER



REAR VIEW  
CAMERA



ANTI-COLLISION  
SYSTEM



OPERATOR  
TRAINING VIDEO  
TUTORIALS



USER MANUALS  
IN 24  
LANGUAGES





The operator is the centre of a high-tech universe, where everything is easy, intuitive and dynamic

All functions and activities are managed from a single interface, where a mere touch of the finger offers access to an extraordinary choice of customizable features to satisfy all types of requirements with extreme simplicity.

The high definition colour display offers the same intuitive experience as a smartphone



Touchscreen Display



#### LOG-IN WITH PASSWORD

Protects your investment from unauthorized or improper use



#### REAR VIEW CAMERA

Increases safety during manoeuvres and helps control cleaning performance



#### OPERATOR TRAINING VIDEO TUTORIALS

Reduce training costs, providing quick instructions on how to perform ordinary maintenance operations

## 9 working programs to achieve the best results with the maximum efficiency



Set your goals: with zone and working programs, you reduce the risk of error, make cleaning operations effective on the first pass and achieve desired results without any uncertainty

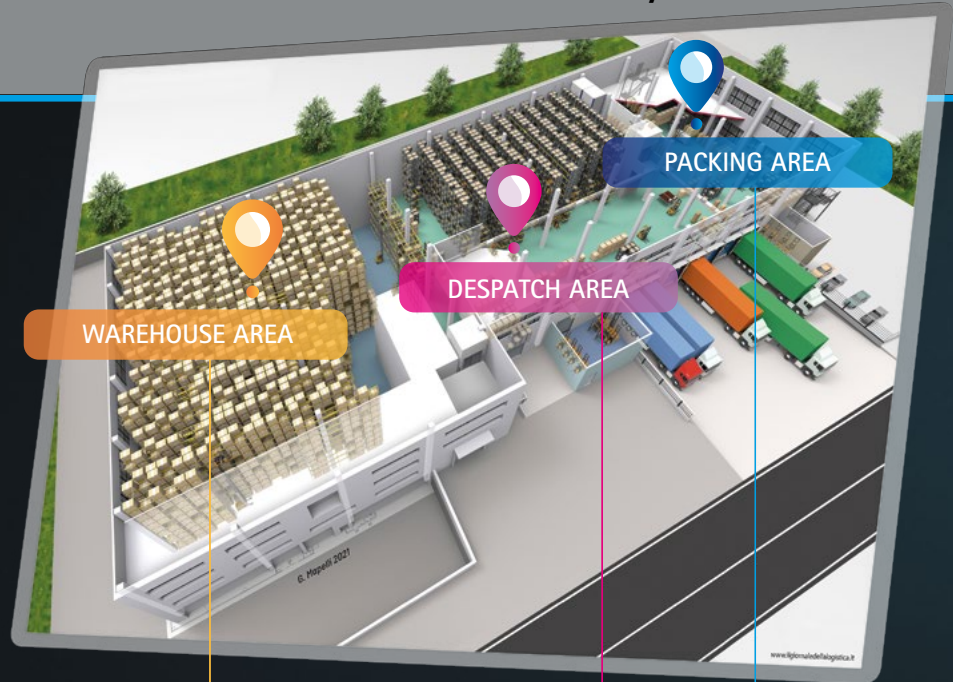

### 4 ZONE PROGRAMS

Set up to 4 zones that are frequent on your cleaning sites to help the operator carry out the task properly.

Save the cleaning settings you consider suitable for each zone; once the zone has been selected, GMG will start working with the configuration you set.



Working programs guide the operator through an intuitive selection of the most suitable cleaning configuration



#### 5. ECO MODE

For light maintenance cleaning, where you can use less resources and work with a low noise level



#### 6. COMFORT MODE

For ordinary, not heavy-duty cleaning, suitable for daily tasks



#### 7. DYNAMIC MODE

For routine cleaning where greater productivity is required, it allows tasks to be done quickly



#### 8. HEAVY MODE

For heavy-duty operations, to clean very dirty floors that require high cleaning power



#### 9. POWER MODE

To get 120 seconds of maximum power and easily remove localized dirt

Some working programs can be selected from either the touchscreen display or the membrane keyboard below





# GMG

## Connect to your fleet, increase productivity with the My.Machine app



FIMAP FLEET MANAGEMENT

Track the performance of your fleet easily, through your smartphone, with the My.Machine app. You can see where your machines are, if the cleaning task is being carried out as planned or if any unexpected event has

occurred. Enter the profile of each scrubber dryer and check the list of servicing performed and anomalies occurred, in order to always be in full control of the situation and keep productivity high.

Manage your fleet remotely with the FFM – Fimap Fleet Management system, use the My.Machine app to access data at any time and don't miss a single detail of the status of your machines



Watch the video



#### INDOOR TRACKING

Tracking of cleaning activities within buildings, to detect which areas have already been cleaned and which are still to be completed.



#### MISSION CONTROL PART PROGRAM

The supervisor can set a weekly cleaning schedule and send it remotely to the machine. This enables the operator to follow the set schedule, ensuring the desired cleaning standards are maintained, and keeping costs low.



#### GEOLOCATION

It shows on a map the machine.



#### USE INFORMATION

It's possible to know in what working mode the machine is operating and for how long. Moreover, it provides information about the duration of each intervention and the sq.m cleaned.



#### HEALTH STATUS

It is possible to monitor the health condition of both machines and batteries at any time, to have a clear view of the fleet availability and optimize its coordination.



#### ENVIRONMENTAL IMPACT

It is possible to see the amount of CO<sub>2</sub> produced by the machine since the beginning of its life cycle.



#### ALARMS

The anomalies occurred are summarized in a list which includes a description of the type of issue, and the date and time of the event. It helps you to have an overview of the improper uses that need to be corrected.



#### SERVICES

An overview of the list of the maintenance services performed allows to identify discrepancies with the health condition of the machine in case an anomaly is detected, and to monitor the inspections of the whole fleet.

## Greater control during interventions raises safety standards



REAR VIEW  
CAMERA

Increases the safety of  
reverse manoeuvres



ANTI-COLLISION  
SYSTEM

The front and rear anti-collision  
system detects obstacles

The front and rear sensors make two different sounds.  
While the machine is moving the operator can recognise by the sound whether the obstacle is in the front or in the rear of the machine.

In the Plus versions, in addition to the sound, the level of approach to the obstacle  
can also be viewed on the display.

The front sensors are automatically activated when the machine drops below a certain speed during forward travel.







## ACTIVE TECHNOLOGIES to prevent accidents

In large spaces where there can be obstacles such as machineries or shelves, GMG always ensures full control of the surrounding space, so that the necessary manoeuvres can be carried out in the utmost safety.

## Greater control during interventions raises safety standards

### ACTIVE TECHNOLOGIES to prevent accidents



Enhances visibility in dim light

TOUCH SCREEN  
DISPLAY



Maintains a constant speed when driving downhill, and prevents sudden increases in speed caused by gravity

DESCENT  
CONTROL



The steering wheel controls offer the operator even greater control when cleaning, and also improve safety by eliminating distractions and letting the operator keep his or her eyes on the zone ahead of the machine

STEERING  
WHEEL  
CONTROLS



The traction control system, which brakes and holds the machine when the accelerator pedal is released, provides assistance for both uphill and downhill gradients

STOP&GO



Control device letting the operator set the required speed

CRUISE  
CONTROL



Is automatically operated when the machine stops. It works as a safety parking brake

ELECTROBRAKE



Self-adjusting, guaranteeing the best braking performance

HYDRAULIC  
DRUM BRAKES



Automatically reduces speed when steering without the operator using the brake

ESC - ELECTRONIC  
STABILITY CONTROL





Protect the operator holding him/ her in case of impact

SAFETY BELTS



To protect operators working in warehouses and logistics centres

OVERHEAD GUARD



Warns about the presence of GMG when visibility is obstructed by shelves or other equipment, avoiding accidents

BLUE SAFETY SPOTLIGHT



Front and rear LED headlights maximize work safety in all conditions

LED HEADLIGHTS



Any questions? GMG has all the answers: the video tutorials help the operator in every phase of the job

OPERATOR TRAINING VIDEO TUTORIALS

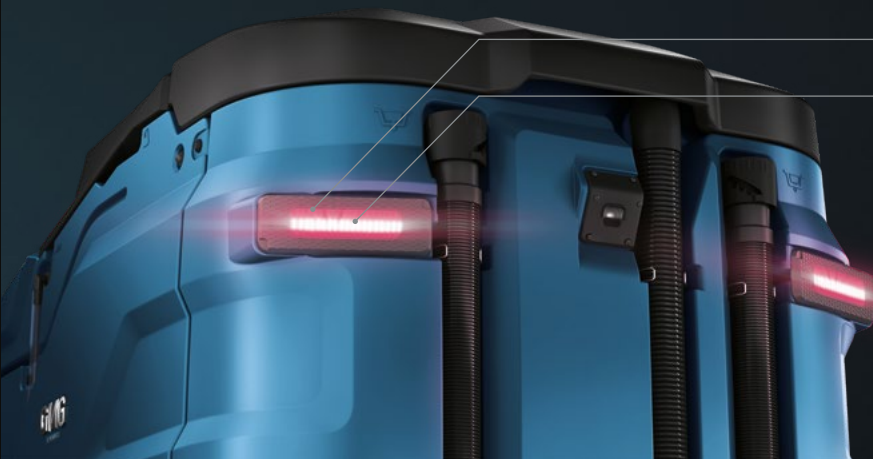

Position lights / Brake lights

Reverse lights

Driving lights

Position lights



## PASSIVE SYSTEMS to help the operator in case of emergency



SOS DEVICE

Reduces time to service in case of emergency. The red button sends an sms alert to receive a prompt help, reducing downtimes



EMERGENCY STOP

By pressing a single button the machine stops immediately



## Choose how to reduce the environmental impact of cleaning operations with Fimap sustainable technologies

GMG always shows you the advantages of a more eco-friendly option

During the cleaning intervention, a projection of how many resources could be saved by activating Eco Mode is shown on the display. In this way the operator can evaluate, if the dirty conditions allow it, to switch to a cleaning configuration that reduces consumption.



The Eco Mode device helps you to not use more resources than necessary. When just a maintenance cleaning is required and dirt is light, you can clean using reduced amounts of water, chemical and energy. By avoiding waste, you can clean more sq.m with less resources



### START&STOP

When the machine is idle, the brush motor, the vacuum motor, the traction and the water flow will turn off automatically, reducing costs and emissions.

All the functions are reactivated automatically as soon as the operator touches the accelerator again

## WATER



**FSS**  
FSS-FIMAP SOLUTION SAVER  
The amount of water and chemical are dosed separately

It reduces water and chemical use by up to **50%**



**FLR**  
FLR-FIMAP LONG RANGE  
System that recycles the cleaning solution, increasing the working autonomy

It reduces water and chemical use by up to **66%\***



**FWF**  
FWF-FIMAP WATER FLOW  
Ensures uniform cleaning results across the entire working width on the first pass, optimising detergent solution consumption

## ENERGY



**FES**  
FES-FIMAP ENERGY SAVER  
The GMG is a machine with many functions, each of which is powered by a dedicated motor. Thanks to its careful design, the various motors have been sized to optimise energy consumption, whilst offering the best performance and maximum efficiency.

It reduces energy consumption by up to **35%**

\* Per cleaning operation. Saving calculated on a triple recycling cycle

# GMG

Choose the version that meets your needs

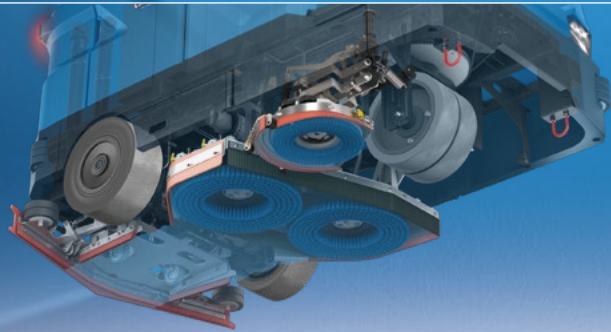

**DUAL DISC**  
with 2 disc brushes  
or 2 pad holders



**CYLINDRICAL**  
with 2 cylindrical brushes and  
a debris hopper for small sized  
solid debris

**DEBRIS HOPPER**  
collects small solid residues

**SCRUBBING**  
the floor is scrubbed with water and  
detergent, and the bristles easily remove  
even the most stubborn dirt

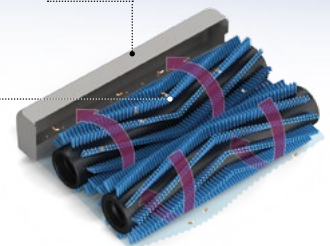





Touch screen  
display

**PLUS**



Membrane  
control panel

**PRO**





# Customize your GMG with the most suitable accessories for your industry

## OPTIONALS



Vacuum wand



Spray gun



The Comfort seat is adjustable and complete with armrests and safety belt

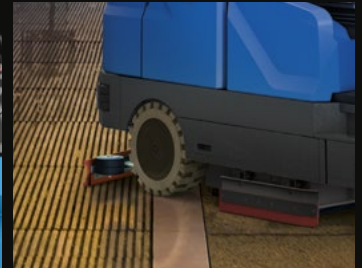

Super elastic wheels



FFF-FIMAP FAST FILL

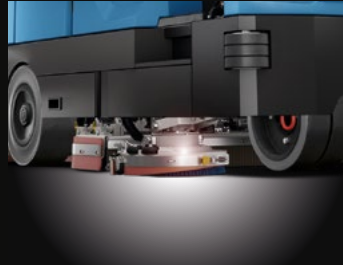

Side scrubbing brush with vacuum system



FFM-FIMAP FLEET MANAGEMENT



Front and rear LED headlights



Service LED lights



Overhead guard



BLUE SAFETY SPOTLIGHT



Power steering



FSS-FIMAP SOLUTION SAVER



FLR-FIMAP LONG RANGE

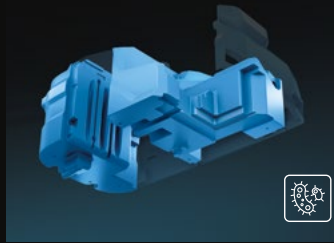

Antibacterial tanks help inhibit the growth of bacteria and mold



USB ports for charging mobile devices



2 sweeping side brushes



Anti-collision system (front - rear)

## ACCESSORIES

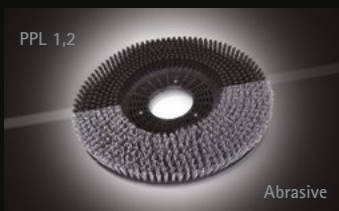

CENTRAL BRUSHES FOR THE DISC VERSION



SIDE BRUSHES FOR THE DISC VERSION



CENTRAL BRUSHES FOR THE CYLINDRICAL VERSION

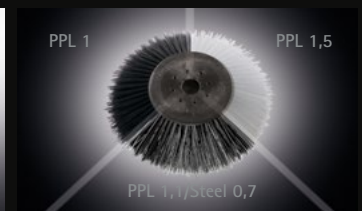

FRONT BRUSHES FOR THE CYLINDRICAL VERSION

A selection of disc or cylindrical brushes is offered for dealing with any type of dirt on any floor

Abrasive brushes:

Suitable for heavy-duty cleaning of industrial floors

The application of a pad holder allows the use of various types of pads according to the treatment to be performed



### REAR SQUEEGEE RUBBER BLADES

33 SHORE (PARA): For maintenance cleaning of smooth floors

40 SHORE (PARA): For stubborn dirt on floors with joints

POLYURETHANE: For heavy-duty cleaning and collecting oil on industrial floors

LINATEX™: Suitable for all surfaces from smooth to uneven, they provide excellent performance because they are more resistant to wear, temperature changes and use of aggressive chemicals



# OPTIONAL AND STANDARD EQUIPMENT

| USER EXPERIENCE   | DUAL DISC |          | CYLINDRICAL         |                      |
|---|-----------|----------|---------------------|----------------------|
|   | GMG Pro   | GMG Plus | GMG Cylindrical Pro | GMG Cylindrical Plus |
| iD-Intelligent Drive:   | -         | •        | -                   | •                    |
| - 9 inch high resolution color touch screen   | -         | •        | -                   | •                    |
| - Log-in with password  | -         | •        | -                   | •                    |
| - Zone programs   | •         | •        | •                   | •                    |
| - Cruise control  | •         | •        | •                   | •                    |
| - Eco Mode  | -         | •        | -                   | •                    |
| - Comfort Mode  | -         | •        | -                   | •                    |
| - Dynamic Mode  | -         | •        | -                   | •                    |
| - Heavy Mode  | -         | •        | -                   | •                    |
| - Power Mode  | -         | •        | -                   | •                    |
| - Power   | •         | -        | •                   | -                    |
| - Digital solution level indicator  | -         | •        | -                   | •                    |
| - Rear view camera  | -         | •        | -                   | •                    |
| - Anti-collision system (front - rear)  | ○         | •        | ○                   | •                    |
| - Operator training video tutorials   | -         | •        | -                   | •                    |
| - User manuals in 24 languages  | -         | •        | -                   | •                    |
| - On-board computer (odometer, telemetry, report of the last cleaning intervention, remaining autonomy) | -         | •        | -                   | •                    |
| - Maintenance due warning   | •         | •        | •                   | •                    |
| - Membrane keyboard with work mode selector   | -         | •        | -                   | •                    |
| Membrane control panel  | •         | -        | •                   | -                    |
| <b>COMFORT</b>  |           |          |                     |                      |
| Hour meter  | •         | •        | •                   | •                    |
| Cleaning solution level indicator   | •         | •        | •                   | •                    |
| Fresh water empty tank light  | •         | •        | •                   | •                    |
| Vacuum wand   | ○         | ○        | ○                   | ○                    |
| Spray gun   | ○         | ○        | ○                   | ○                    |
| Basic seat  | •         | -        | •                   | -                    |
| Adjustable Comfort seat complete with armrests and safety belt  | ○         | •        | ○                   | •                    |
| FFF (Fimap Fast Fill)   | ○         | ○        | ○                   | ○                    |
| Automatic coupling/uncoupling of the central brushes  | •         | •        | -                   | -                    |
| Noiseless suction   | •         | •        | •                   | •                    |
| Brush and squeegee actuator   | •         | •        | •                   | •                    |
| Power steering  | ○         | ○        | ○                   | ○                    |
| Super elastic wheels  | ○         | ○        | ○                   | ○                    |
| Rear footboard for easy maintenance   | •         | •        | •                   | •                    |
| USB ports for charging mobile devices   | ○         | •        | ○                   | •                    |
| <b>PRODUCTIVITY</b>   |           |          |                     |                      |
| Water flow selector   | •         | •        | •                   | •                    |
| Triple pressure selector  | -         | -        | -                   | -                    |
| Extra pressure  | •         | •        | •                   | •                    |
| Vacuum speed selector   | •         | •        | •                   | •                    |
| Side scrubbing brush with vacuum system   | ○         | ○        | -                   | -                    |
| 2 sweeping side brushes   | -         | -        | ○                   | ○                    |
| 2 3-stage vacuum motors   | •         | •        | •                   | •                    |
| FFM (Fimap Fleet Management) with SOS device, mission control part program and indoor tracking          | ○         | ○        | ○                   | ○                    |
| Squeegee with anti-corrosion treatment  | •         | •        | •                   | •                    |
| Side splash guards  | •         | •        | •                   | •                    |
| Rear-wheel traction with 2 independent motor wheels   | •         | •        | •                   | •                    |
| Brushless motors (traction, brushes, vacuum)  | •         | •        | •                   | •                    |
| Batteries with automatic refilling system   | ○         | ○        | ○                   | ○                    |
| Ramp up   | •         | •        | •                   | •                    |
| <b>SAFETY</b>   |           |          |                     |                      |
| Blinking light  | •         | •        | •                   | •                    |
| Driving LED lights (front-rear)   | ○         | •        | ○                   | •                    |
| Service LED lights  | ○         | •        | ○                   | •                    |
| Stop&Go   | •         | •        | •                   | •                    |
| Descent control   | •         | •        | •                   | •                    |
| ESC (Electronic Stability Control)  | •         | •        | •                   | •                    |
| Emergency Stop  | •         | •        | •                   | •                    |
| Overhead guard  | ○         | ○        | ○                   | ○                    |
| Antibacterial tanks   | ○         | ○        | ○                   | ○                    |
| Blue safety spotlight   | ○         | ○        | ○                   | ○                    |
| Hydraulic rear drum brakes  | •         | •        | •                   | •                    |
| Electrobrake  | •         | •        | •                   | •                    |
| <b>ENVIRONMENT</b>  |           |          |                     |                      |
| FSS (Fimap Solution Saver)*   | ○         | ○        | ○                   | ○                    |
| FLR (Fimap Long Range)*   | ○         | ○        | ○                   | ○                    |
| FWF (Fimap Water Flow)  | •         | •        | -                   | -                    |
| FES (Fimap Energy Saver)  | •         | •        | •                   | •                    |
| Start&Stop  | •         | •        | •                   | •                    |

(\*) The two devices cannot be installed together

• STANDARD      ○ UPON REQUEST      - NOT AVAILABLE

# DIMENSIONS AND TECHNICAL DATA

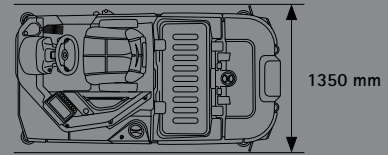
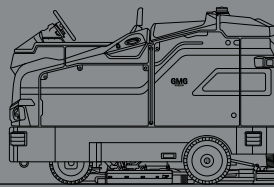
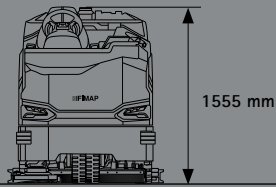

2310 mm

| TECHNICAL DATA – GMG   |             | DUAL DISC                                |          | CYLINDRICAL         |                      |
|--|-------------|--|----------|---------------------|----------------------|
|  |             | GMG Pro                                  | GMG Plus | GMG Cylindrical Pro | GMG Cylindrical Plus |
| Productivity theoretical   | up to sqm/h | 12000                                    |          | 13000               |                      |
| Estimated coverage   | up to sqm/h | 10800                                    |          | 11700               |                      |
| <b>SCRUBBING SYSTEM</b>  |             |  |          |                     |                      |
| Working width  | mm          | 1000                                     |          |                     |                      |
| Working width with side brushes  | (no.) mm    | (1) 1200                                 |          | (2) 1300            |                      |
| Brush motors   | (no.) V/W   | (2) 36/1500                              |          | (2) 36/1800         |                      |
| Brush rpm (central / side)   | rpm         | 315/140                                  |          | 720/105             |                      |
| Brush pressure   | up to kg    | 250                                      |          |                     |                      |
| <b>TANK AND RECOVERY SYSTEM</b>  |             |  |          |                     |                      |
| Solution tank  | l           | 300                                      |          |                     |                      |
| Recovery tank  | l           | 350                                      |          |                     |                      |
| Suction motor  | V/W         | (2) 36/600                               |          |                     |                      |
| Vacuum water lift  | mbar        | 200                                      |          |                     |                      |
| Detergent tank capacity (FSS)  | l           | 32                                       |          |                     |                      |
| Maximum volume of the debris hopper  | l           | -  |          | 47,5                |                      |
| <b>BATTERY SYSTEM</b>  |             |  |          |                     |                      |
| Supply/traction  | V           | 36/aut.                                  |          |                     |                      |
| Batteries  | (no.) V/Ah  | (1) 36/510-625-775 WET - 38,4/720 Li-ion |          |                     |                      |
| Battery run time*  | up to h     | 6 (WET) - 10 (Li-ion) *                  |          |                     |                      |
| <b>PROPELLING SYSTEM</b>   |             |  |          |                     |                      |
| Forward working speed  | km/h        | 9  |          |                     |                      |
| Transport speed  | km/h        | 10                                       |          |                     |                      |
| Gradeability<br>(Working / Transport at gross weight / Trailer ramp empty) | %           | 20 / 25 / 30**                           |          |                     |                      |
| Traction motor   | (no.) V/W   | (2) 36/3300                              |          |                     |                      |
| <b>SPECIFICATIONS</b>  |             |  |          |                     |                      |
| Machine dimensions (L x h x w)   | mm          | 2310<br>1555<br>1250                     |          |                     |                      |
| Squeegee width   | mm          | 1350                                     |          |                     |                      |
| Machine weight empty without batteries                                     | kg          | 985                                      |          | 1010                |                      |
| Machine weight empty with batteries  | kg          | 1795                                     |          | 1820                |                      |
| GVW (Gross Vehicle Weight)   | kg          | 2215                                     |          | 2205                |                      |
| Sound pressure level (ISO 11201) – L <sub>PA</sub> – Eco Mode              | dB (A)      | 67                                       |          |                     |                      |
| Minimum aisle turn   | mm          | 2500                                     |          |                     |                      |

\*Run times are based on continuous scrubbing run times - \*\*With hoist  
Machine weights are calculated on the basis of a standard reference model

# SERVICES

## CONSULTING AND PLANNING



We put our experience at your service, to help you realize the cleaning project perfect you. We suggest you the best solutions to make costs decrease and service quality increase.

## SETUP



We can help you set up your machines in order to make them meet specifically the requirements of the sites of your project, allowing you to always have control over costs and results.

## AUTHORIZED WORKSHOP NETWORK



Fimap Authorized Workshop network spans the globe, so you can enjoy the peace of mind of finding a professional support wherever your business is.

## CONFIGURATION



Your business is unique, only a customized fleet can lead you to better results. We will help you find the configurations that best fit the specific requirements of your cleaning sites, in order to optimize processes and lower costs.

## TRAINING COURSES



Fimap Academy offers courses for all levels, from the correct use of machines and technologies, up to the management of sites and tenders, helping you to make your service really competitive.

## MAINTENANCE AND REPAIR



For your business to run smoothly it is essential that your machines are kept always operational. Our technicians take care of monitoring the machines health status and know how to intervene quickly and effectively when needed.

## FINANCIAL SOLUTIONS



You can choose to use the fleet in different ways. We can advise you on the best financial solution for your business, so that you can get the quality of the Fimap world at the most convenient conditions for you.

## DIGITAL FLEET MANAGEMENT SYSTEM



With Fimap Fleet Management everything is under your control. You can have a complete overview of the service provided and find out the improvements that can be made, basing your considerations on real data, always available via the MyMachine app or FFM website.

## GENUINE SPARE PARTS



Get the most out of your machines, choose the reliability of Fimap original spare parts. They are designed together with the machines, so they perfectly fit them thus guaranteeing the highest quality of performance.

## CERTIFICATIONS



## AWARDS



For any additional information or for a demo please contact your usual Fimap dealer



FIMAP spa – Via Invalidi del Lavoro, 1 – 37059 S. Maria di Zevio – Verona – Italy – Tel. +39 045 6060411 – Fax +39 045 6060417 – E-mail: [fimap@fimap.com](mailto:fimap@fimap.com)

